

Alle Maße sind Mindestmaße in mm
all dimension are minimum in mm

Stempelabstand 1500 (Ölhydraulik)
piston distance 1500 (oil hydraulics)

= Mindestmaß, sonst nach Bodenbeschaffenheit
= minimum, otherwise acc. to foundation requirements

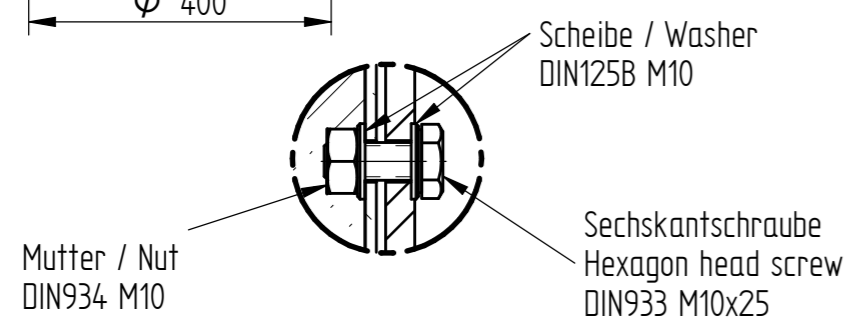

max. Tragkraft [kg]	3500	5000	6500
MbX [Nm]	2 x 13.500	2 x 31.000	2 x 41.500
MbY [Nm]	2 x 12.500	2 x 18.000	2 x 23.000
Fmax [kn]	45	65	85

HERRMANN
Herrmann AG | Bahnhofstr. 32 | 93483 Posing

Zeichnungsnummer
FP HK 1500

Fundamentplan HK SA1500
Foundation plan HK SA1500

Stand
30.01.26
Zst. 2